

WATER COOLED

Water Cooled Packaged Units



Product of the year category



CWP 63 ~ 1030



**NOMINAL
COOLING CAPACITY**

HWP 3.5kW ~ 44.5kW
CWP 6.27kW ~ 101.6kW
Heating figure based on reverse cycle

**NOMINAL
HEATING CAPACITY**

HWP 3.7kW ~ 42.2kW
CWP 6.63kW ~ 98.6kW
Heating figure based on reverse cycle



**Over 60 years
of innovation**



We're dedicated to pioneering innovative new technologies which make installation a breeze and provide perfect comfort all year round.

The sky's the limit with Temperzone water-cooled systems

When buildings head skyward, only Temperzone's water-cooled air conditioning system have what it takes to meet your climate control challenges.

A key fixture of many CBD high-rise developments throughout Oceania and Asia, our innovative water-cooled units are more reliable, economical, flexible, and environmentally friendly than most air-cooled alternatives.

While other systems struggle to deliver as the floors stack up, our technology has been engineered to deliver optimum performance in multi story buildings particularly those exceeding 15-storeys.

Why water-cooled units lead the way up high

Temperzone's water-cooled technology combines the benefits of a water-cooled condenser with an air-cooled evaporator, delivering a level of performance that air-cooled units can't.

Available in capacities from 3.5kW to 101.6kW, they're also designed to run on individual power sources, eliminating the need to install expensive central plants. And because they're designed to fit into virtually any internal space or cavity, they're ideal for high-rise buildings that prohibit the use of balcony units.

Temperzone water-cooled systems can play a central role in developing a sustainable energy strategy or energy upgrade for any building.



Horizontal Wall Cooled Package
(HWP)

03



Vertical Water Cooled Package
(CWP)









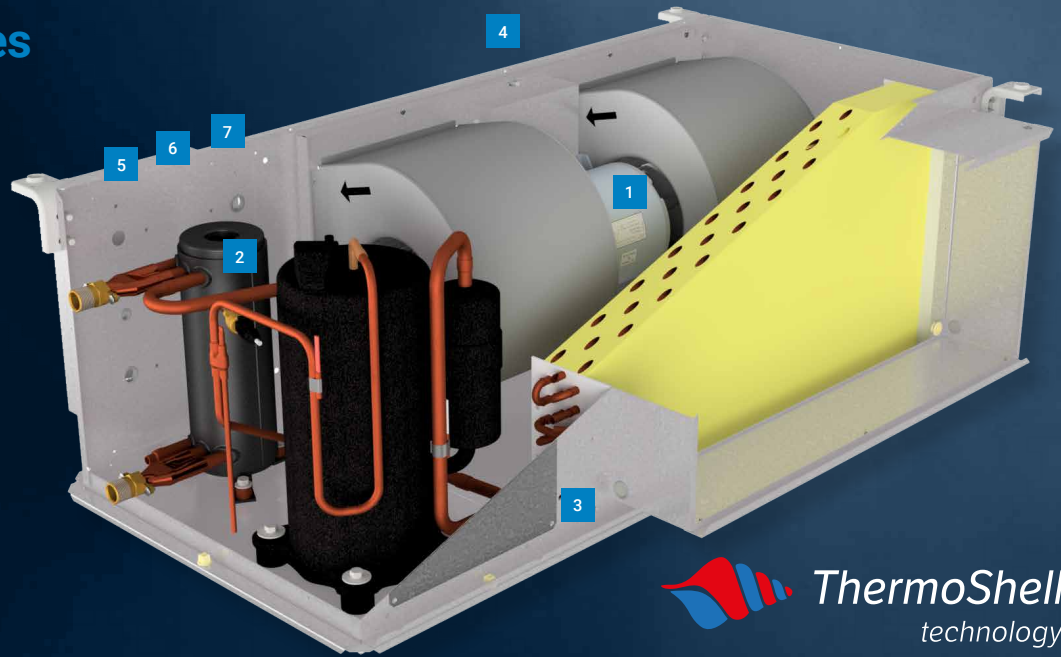



17

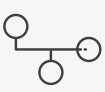

HWP Eco Range

HWP-Y Series



			
<p>1</p> <p>HIGH EFFICIENCY EC FAN Can be controlled either as a speed or by 0-10VDC.</p>	<p>2</p> <p>THERMOSHELL Lower pressure drops. Water loop Anti Fouling design. Higher Performance.</p>	<p>3</p> <p>COMPACT Made to fit most applications.</p>	<p>4</p> <p>WIDE ESP With EC fan technology air balancing is simple.</p>
			
<p>5</p> <p>EXTERNAL CONTROL Can be operated through relays. Simple terminals for compressor control on/off and modulation, fan speed and cycle modes.</p>	<p>6</p> <p>LOCAL KEY PAD Can operate with selected Temperzone local controllers.</p>	<p>7</p> <p>BMS Can be controlled though RS485 Modbus. This also provides a wealth of data.</p>	<p>8</p> <p>ELECTRONIC EXPANSION VALVE The HWP 142 ~ 275 have electronic expansion valves for greater control and efficiency.</p>
			
<p>9</p> <p>WIDE RANGE WATER TEMPERATURE Water temperatures from -5°C to +50°C *Conditions apply.</p>	<p>10</p> <p>COOLING ONLY All HWP units are available made to order as cooling only.</p>	<p>11</p> <p>REVERSE CYCLE All HWP units are available as reverse cycle for projects that require heating from the water loop.</p>	<p>12</p> <p>COOLING WITH ELECTRIC HEATING All HWP units are available as cooling only with additional electric heaters. Heaters have double high temperature safeties.</p>

Simultaneous Cooling and Heating

Simultaneous same-floor cooling and heating via a single water piping system



The lower end of cooling and heating functions have been extended to enable a water temperature operating range to 5°C, creating a wider spectrum of potential applications.

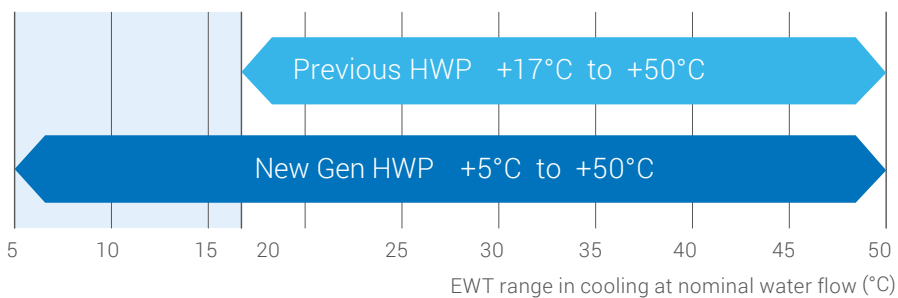

* Min. 5°C with water regulating valve, Min. 15°C without water regulating valve.

HWP-ECO Range

(HWP-Y)

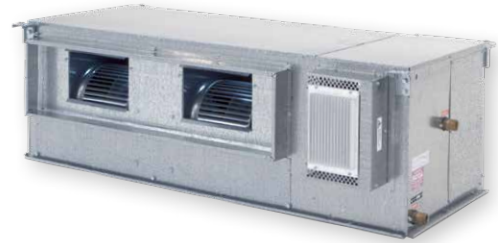

The HWP-ECO Series has been developed with many innovative features allowing for complete flexibility and control in many applications

ThermoShell® Efficiency Water Side Heat Exchanger



Offering up to **6% reduction** in nominal water flow rate and up to **34% reduction** in water pressure drop, Temperzone's state-of-the-art ThermoShell® sets new standards in water-cooled technology.

Enabling a reduction in hydronic equipment size, it reduces capital and operating costs while increasing building sustainability.

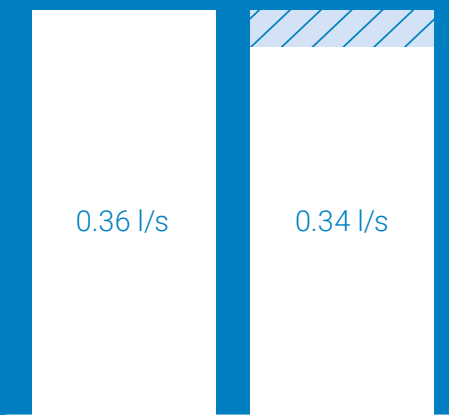
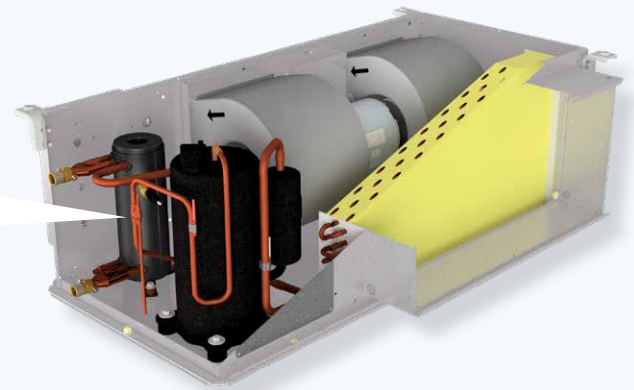
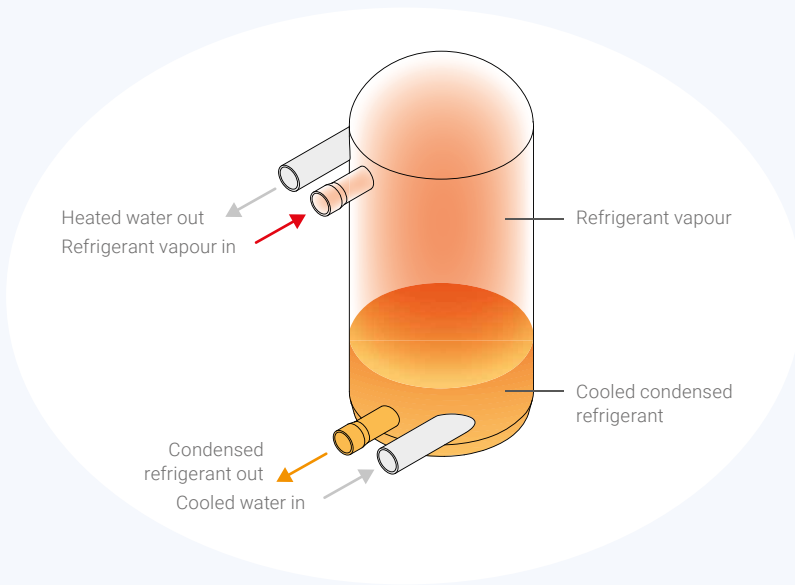

6%
reduction
Nominal
water flow
rate

Previous HWP 58

ThermoShell HWP 59



34%
reduction
Water
pressure
drop

Previous HWP 96

ThermoShell HWP 98



Technological Advancements

Cost Savings with ThermoShell®

Temperzone's state-of-the-art ThermoShell® sets new standards in water-cooled technology.

ThermoShell® technology is Temperzone's new high performance, compact heat-exchanger for refrigerant and water systems.

ThermoShell® enables considerably lower water flow rates and water pressure drops to be accommodated by the system, with minimal effect on duty and efficiency. This leads to a reduction in hydronic equipment size, reducing capital and operating costs.

The effect of a decreased water flow rate through a non EC Fan model HWP 59 with ThermoShell® was measured under laboratory conditions to examine the overall effect on duty and EER*.

It was shown that increasing the temperature differential across the condenser to 9°C by significantly decreasing the water flow rate had only a minimal effect on the duty and EER of the unit (from 3.65 to 3.43).

Also, individual units will run much more efficiently when only a proportion of the units are operating at any one time. Therefore, real world efficiencies will be greater than design efficiencies.

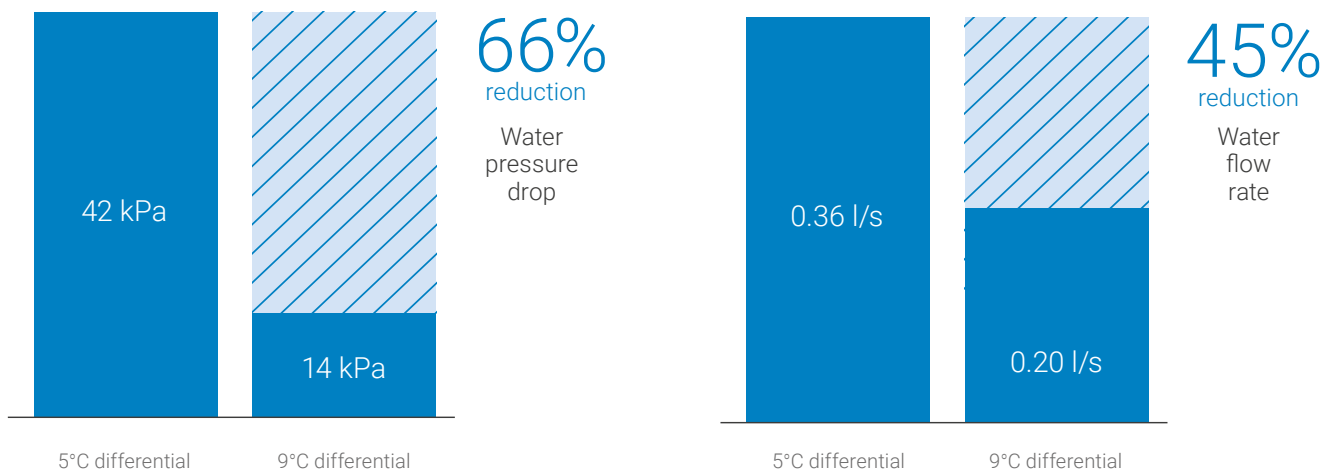

* HWP 59 was tested under typical conditions of IAT 27/19°C, EWT 30°C,

Life Long Efficiency

Unlike coaxial and plate-type heat exchangers, ThermoShell® prevents degradation in heat transfer efficiency due to water fouling, facilitating reliable operation throughout the unit service life.

ThermoShell® Heat Exchanger

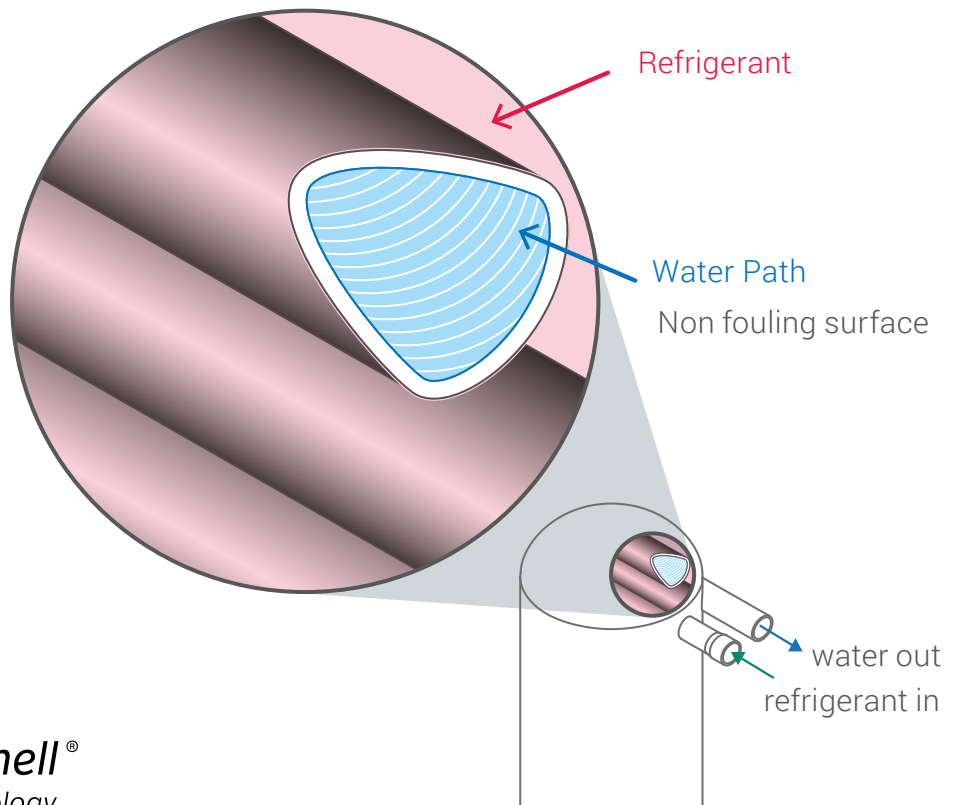

Coaxial Heat Exchanger

Piping has a very undulated surface making it prone to extreme water fouling.

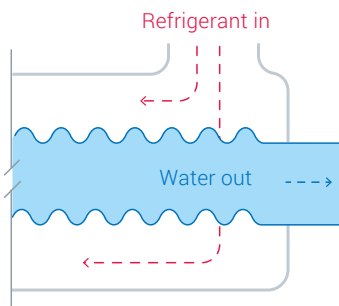
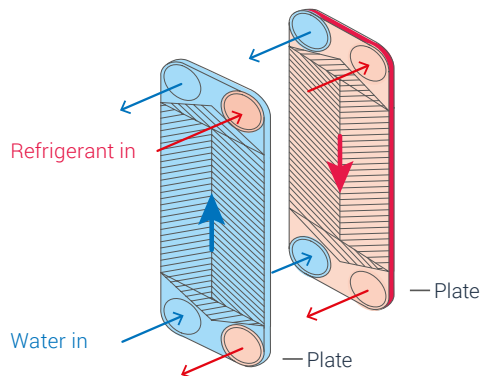

Plate Heat Exchanger

Many plates at extremely close intervals create a very receptive fouling surface.



Efficiency

Greater Design Flexibility

ThermoShell's wider water temperature operating range offers greater flexibility when retrofitted into any older installations.

In buildings where the condenser water loop is over 15 years old electric heating was widely used. As these buildings lack boilers, the addition of reverse cycle units can lead to the problem of unstable operation in heating mode.

In contrast, ThermoShell heat exchangers enable a wider water temperature operating range, allowing for greater flexibility in the condenser water loop and a maintenance of stable operation.

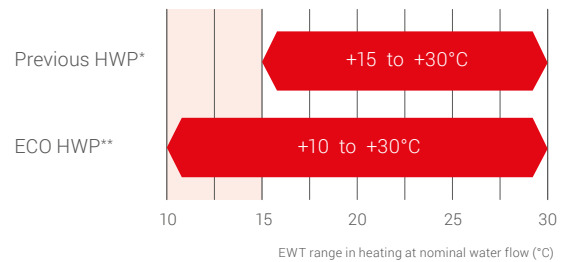
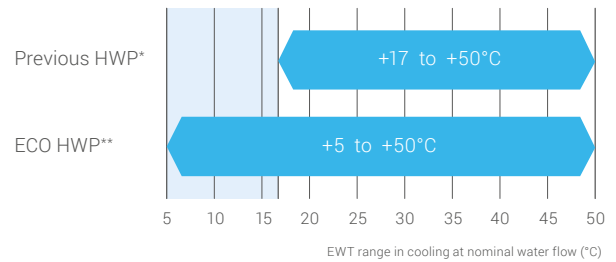

* HWP 96 ** HWP 98

Efficiency

Significant Capital Savings

It can be seen that increasing the temperature differential across the condenser to 10°C has **minimal effect on the duty or EER of the units**, the increase in LWT occurs at system design conditions with the majority of operating conditions at slightly lower total system capacity than design conditions.

The reductions in pressure drop achieved by increasing the LWT up to a 10°C differential temperature is considerable, enabling a reduction in both pipe and pump sizes throughout the building leading to reduced costs in capital equipment and running costs.

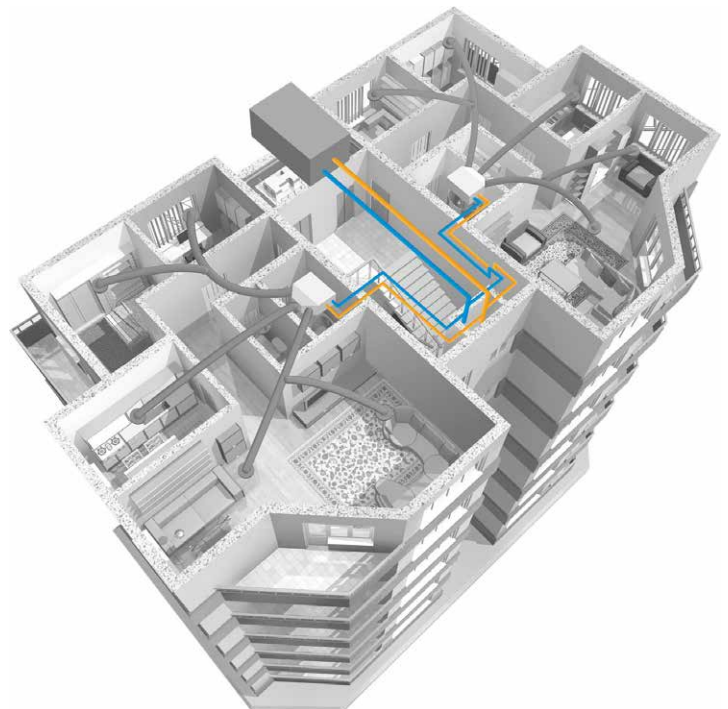

Efficiency

ThermoShell Project Savings

There are considerable capital cost savings in the installation of a system if the water flow rate, under design conditions, can be reduced.



Doubling the temperature differential across the condenser results in:

- A halving of the water flow rate.
- A quarter of the pressure drop the pump has to overcome.

This allows the pipe and pump sizing to be reduced, which results in the lowered capital cost.



The advantages of an increased design temperature differential needs to be balanced with the reduction in the duty and the efficiency of the unit under design conditions.

The effect of decreased flow rate through the ThermoShell was measured under laboratory conditions and the results are presented on the following slides.



HWP 59 Performance Test

HWP 59 was tested under typical conditions of OAT 35°C, IAT 27/ 19°C, EWT 30°C with LWT ranging from 35-45°C.

EWT (°C)	30	30	30	30	30	30
LWT (°C)	35.1	37.1	39.0	41.2	43.5	45.5
Flow (l/s)	0.36	0.25	0.20	0.16	0.13	0.11
Duty (kW)	5.66	5.56	5.46	5.35	5.25	5.16
Power (kW)	1.55	1.56	1.59	1.64	1.70	1.74
EER	3.65	3.56	3.43	3.26	3.09	2.97
Water duty (kW)	7.67	7.54	7.52	7.50	7.37	7.12
Pressure drop (kPa)	42.0	17.5	14.0	7.0	3.5	3.5

HWP 59 Performance Test

A **5°C increase in LWT** results in water flow rates down from **0.36 l/s to 0.18 l/s** and a pressure drop decrease from **42kPa to 10kPa**. This graph illustrates no significant corresponding change to duty power and EER.

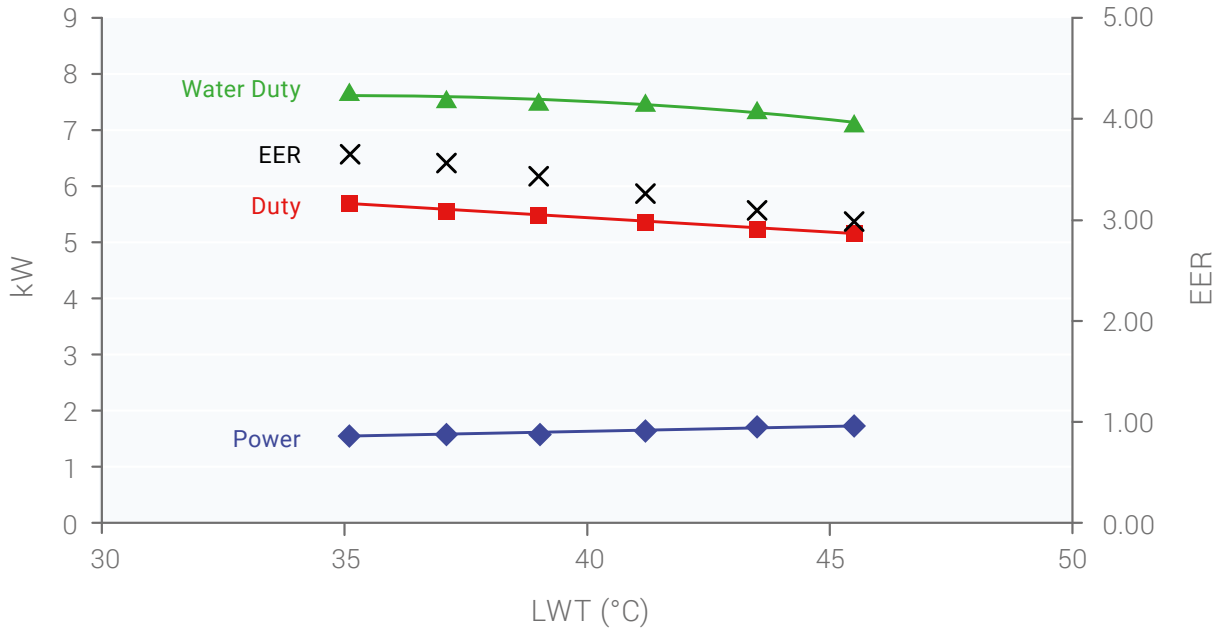

HWP 79 Performance Test

HWP 79 was tested under typical conditions of OAT 35°C, IAT 27/ 19°C, EWT 30°C with LWT ranging from 35-45°C.

EWT (°C)	30	30	30	30	30	30
LWT (°C)	35.1	37.1	39.0	41.2	43.5	45.5
Flow (l/s)	0.53	0.35	0.28	0.22	0.18	0.16
Duty (kW)	7.99	7.72	7.65	7.52	7.36	7.31
Power (kW)	2.01	2.06	2.10	2.16	2.20	2.25
EER	3.98	3.75	3.64	3.48	3.35	3.25
Water duty (kW)	11.00	10.70	10.50	10.20	10.20	9.82
Pressure drop (kPa)	70	28	21	14	7	7

HWP 79 Performance Test

A **5°C increase in LWT** results in water flow rates down from **0.53 l/s to 0.25 l/s** and a pressure drop decrease from **70kPa to 17kPa**. This graph illustrates no significant corresponding change to duty power and EER.

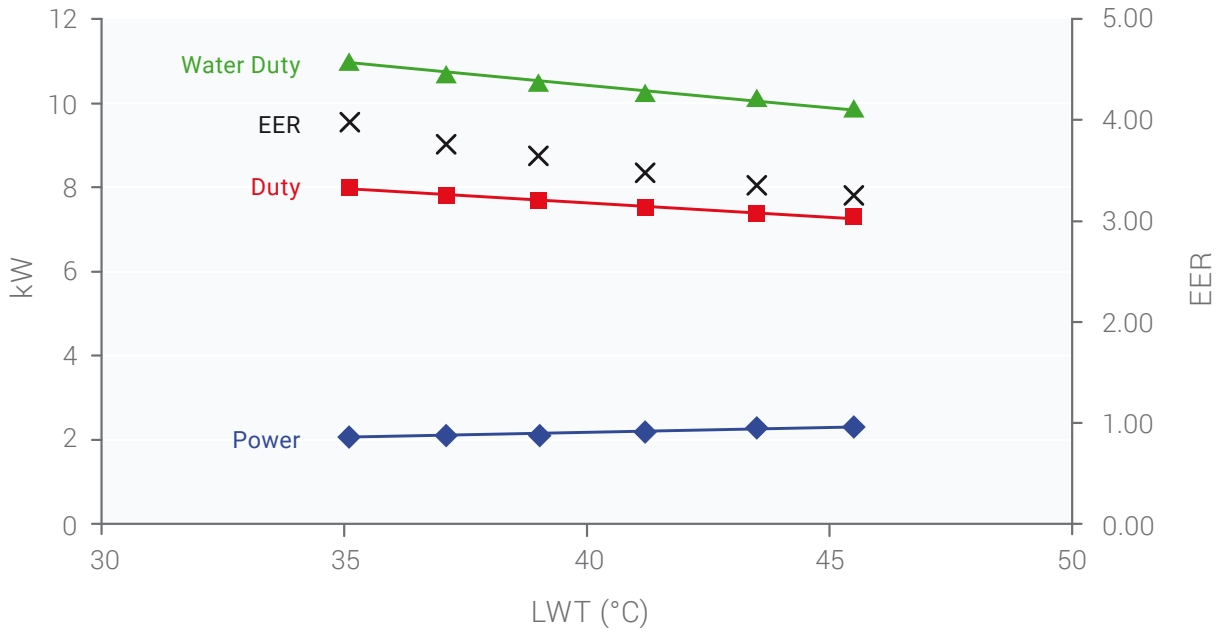

ThermoShell Case Study

This apartment project in Melbourne, with over 200 ThermoShell units, utilised the water-flow flexibility the ThermoShell allows to gain significant capital and installation savings:

- Delta T changed from 5.5 to 11.5 on average.
- Flow rate reduced from approximately 70 l/s to approx 33 l/s.

Original design pump sizes were 2 x 18.5kW pumps, revised design reduced them to 2 x 11kW pumps.

Original design required a main 250mm steel riser, before tapering down. Revised design reduced main riser to 150mm copper.



Control

Temperzone's individual UC Intuitive control system makes it easy to maintain a space at the prescribed temperature.

The UC pcb not only protects the unit operation but it also provides many other key functions. It has the ability to be controlled by three different control methods (low level, local control and BMS)

The HWP Range offers three levels of control:



Third Party, low level

Simple terminals allow connection to any 12VDC /24VDC controller where fan speed, mode and operation can be controlled (all HWP models).



Local Control

Incorporating the UC8 controller (models from HWP36~275) can be connected to a touch mini, TZT100 or SAT-3 controller via RS485 modbus.

TOUCH MINI

- Infrared approaching sensor
- ECO Energy Saving Setting
- Self-Learning Function
- 7 Day Timer Function
- 3 speed fan control



TZT-100

- Auto change over between cool and heat
- 7 Day programmable time clock
- Key board and temperature locks
- 3 speed fan control
- Programmable occupancy inputs
- Auto start after power failure



SAT-3

- Input for remote on/off start
- 7 Day programmable time clock
- Sleep function
- On demand timer count down timer up to 3hrs
- Set temperature: -15 ~ 30C at 0.5C increments
- Auto start after power failure



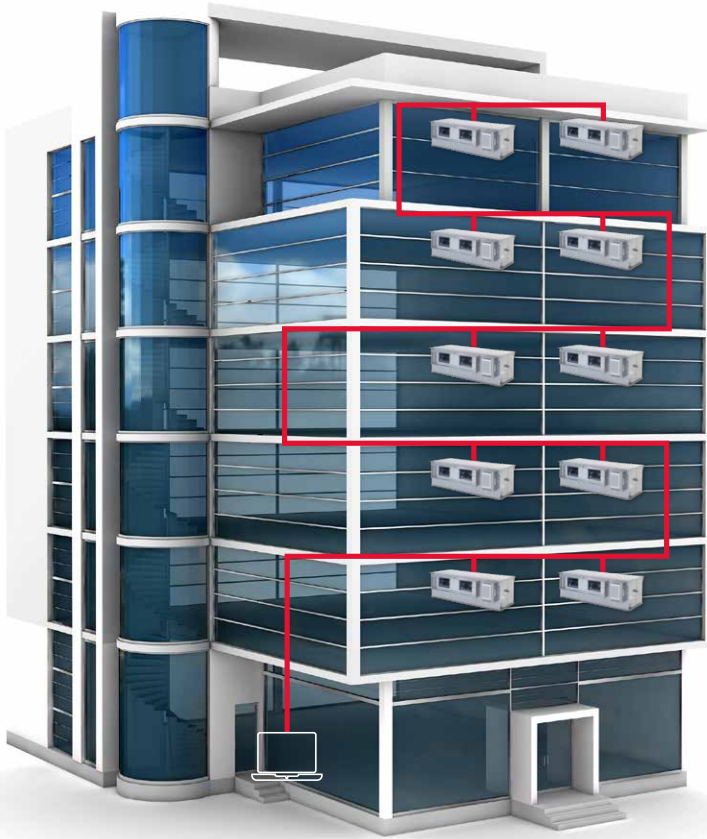

BMS Connectivity

HWP models from 36~275 can be controlled by a BMS via modbus/RS485 port with multi-unit control capability.

- Up to 99 units can be connected on a common RS485 bus in daisy chain design
- BMS communication cable (2-wire shielded)
- Maximum cable length of 1000m

Benefits of BMS connectivity

- In some applications cable requirements are reduced from 11 wires to 2 with greater level of control
- Installation of 3rd party BMS relay boards are not required providing substantial savings
- Reduced wiring and labour
- Ability to monitor units from PC
- Ability for global scheduling
- Ability to view faults and operation data

Temperzone's intuitive UC technology makes it easy

The UC controller has many powerful features and is extremely flexible providing solutions that meet today's requirements.

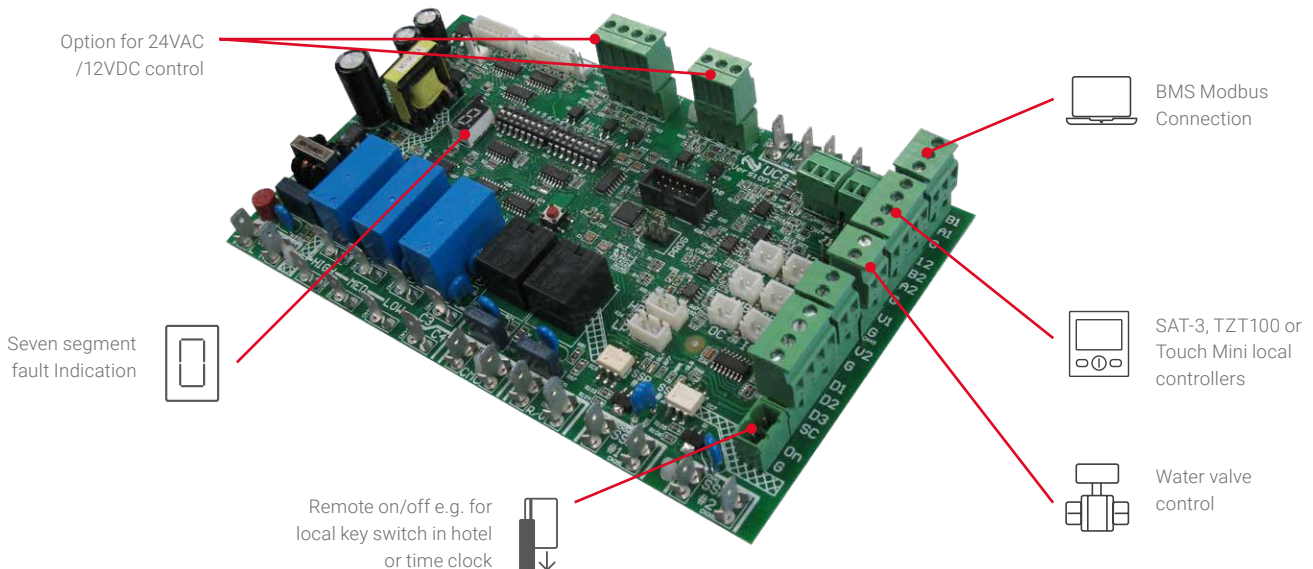



Water Valve Control

The UC controller can operate a modulating water valve or a on/off shut off valve.

The water regulating valve 0-10VDC reference can be provided directly from the UC controller in the HWP. The water regulating valve will be controlled to obtain an optimum condensing temperature providing a higher EER at varying air on conditions.

When the unit is off the water valve control signal is at 0V, which closes the valve and stops the water flow providing the ability to reduce pump energy consumption.

When a call to cool or heat occurs the initial valve control signal is set to 10V to fully open the valve. The valve (10VDC) is given 40 seconds of time to open before the compressor is started.

When the unit is cooling the valve control signal will vary to obtain the optimum condensing temperature for efficient operation of the unit.

The valve will modulate in cooling but will operate at 100% open in heating.

The other benefits of controlling the valve directly from the HWP is that no 0-10VDC BMS card is required, less wiring and no accessing the refrigeration system.

*See technical data manual for applicable valves

The UC controller can be used to power a water shut-off valve. This will ensure the water is not flowing through the unit when it is not operational for a long period of time. This reduces the overall central pump power usage.



Flush Cycle

The UC controller has a flush cycle feature. If the valve has been closed for 24hrs it will briefly open to flush the water in the unit and move the valve to prevent seizing.

A water flush request can be remotely issued via Modbus communications over RS485 wiring. It will cause the water valve to fully open for the duration of the request. The request is only effective when the unit is off (not cooling, not heating).



Pump Call

The UC controller has built in pump call relays that activate whenever the compressor is required to run. The pump call output is solid relay contacts. The contacts are voltage-free, suitable for 24V AC or 230V AC, maximum current is 0.25A. The solid-state relay cannot switch DC signals.

This provides a convenient way to manage the pump call other than operating it through a BMS.



Remote Start/Stop

A remote on/off signal can be connected to the "On" and "0V" terminals (input for a voltage-free switch or relay contact). To turn the unit on the remote on/off input must be **closed-circuit**. The compressor minimum run-time is 90 seconds.

Remote on/off is ideal for connection to key locks or motion detection in a hotel or apartment to automatically switch the unit off when not required.

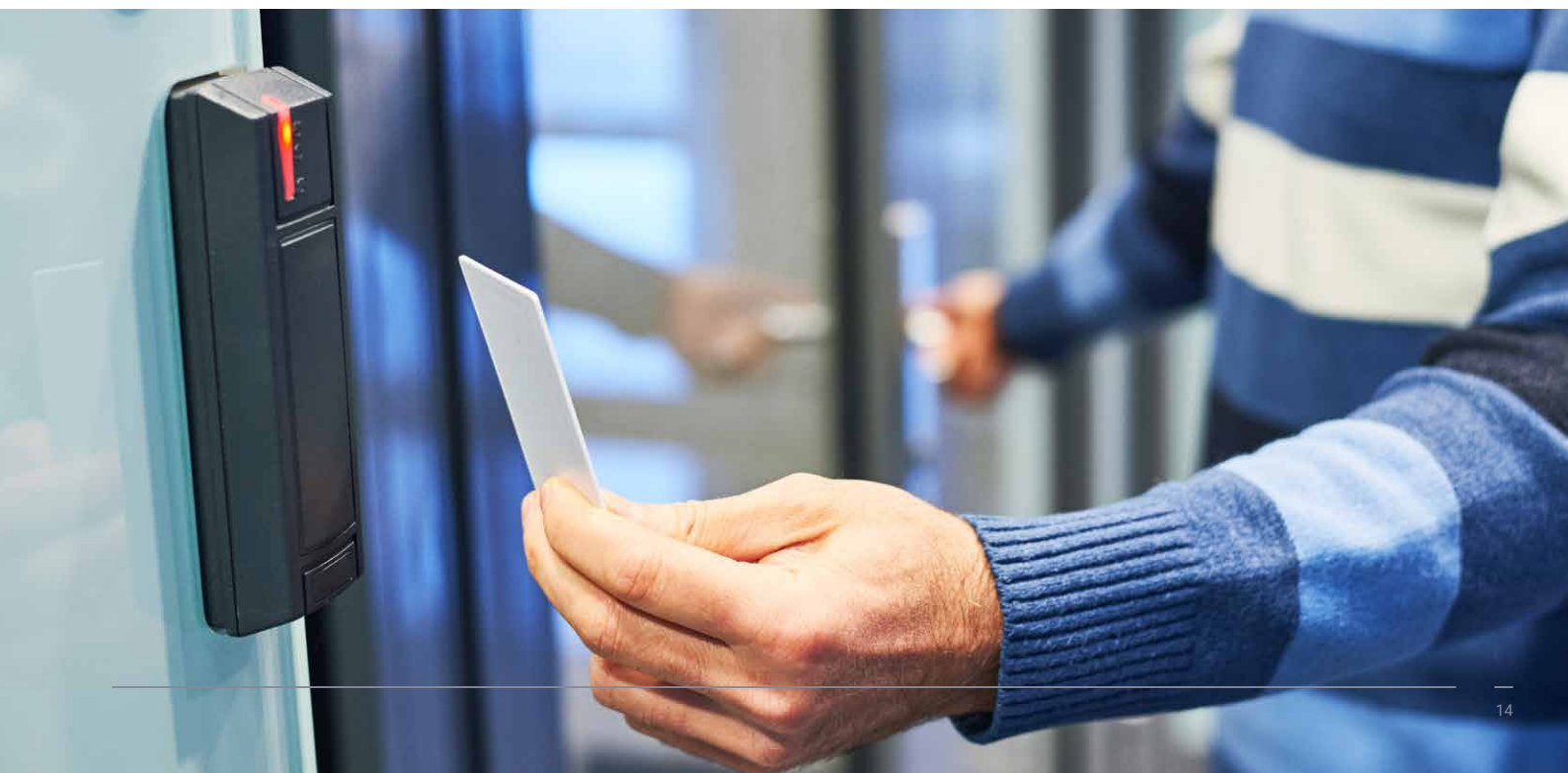

HWP Options & Features

The range of options available allow you to customise your desired unit, giving you ultimate control and flexibility.

Eco Range

Series	HWP	HWP
Model	36 ~ 118	142 ~ 275
EC Fan Motor (Y) version	●	●
G2 Filter	●	●
Reverse Cycle	●	●
Cooling Only	□	□
Cooling /Electrical Heat	●	●
0-10VDC Fan Speed Control	●	●
Handing Options	□	□
BMS Connection	●	●
Modbus connect to touch mini, TZT100 or SAT3 controller	●	●
Pump Call	●	●
Electronic Expansion Valves	—	●

Standard Range

Series	HWP	HWP	HWP
Model	36 ~ 118	142 ~ 275	370 ~ 445
G2 Filter	●	●	●
AC Fan Motor version	●	●	●
Reverse Cycle	●	●	●
Cooling Only	□	□	□
Cooling /Electrical Heat	●	●	●
0-10VDC Fan Speed Control	—	—	—
Handing Options	□	□	□
BMS Connection	●	●	—
Pump Call	●	●	●
Electronic Expansion Valves	—	●	—

- Option — N/A
- Standard

Flexible Handing Options

Flexible handing configurations available to suit the application.

Standard Handing





Std configuration	Front RH	Side RH
Electrical Panel	•	
Water Connections		•

Opposite Handing

Std configuration	Front LH	Side LH
Electrical Panel	•	
Water Connections		•









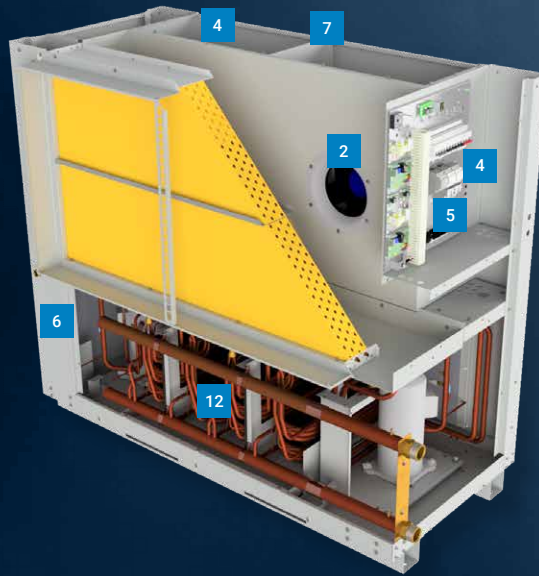

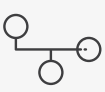

Opposite handing units are not stocked. They are made to order for specific projects.

Additional Options & Accessories

			
<h3>Flexible Hoses</h3>	<h3>Drain Pumps</h3>	<h3>Controller</h3>	<h3>Spring Kit</h3>
<p>HWP models 36 ~ 275 come standard with hoses. Hoses are optional for the HWP 370 & 445</p>	<p>The optional HWP Series Condensate lift-pump has been designed to remove condensate from the unit in tight installations where a well sloped drain line (minimum 1 in 50 gradient) is not immediately feasible. Available on all models 35 ~ 445</p>	<p>Optional controllers include:</p> <ul style="list-style-type: none"> • SAT3 • TZT100 • Touch mini <p>All of these controllers are rich in features and can be connected to the Eco HWP models via RS485 modbus.</p>	<p>HWP models 36 ~ 445 come standard with spring mounting kits.</p> <p>Spring mounting kits can be purchased separately if required.</p>

CWP Vertical Package Units



			
<p>1</p> <p>HIGH EFFICIENCY EC FAN EC fans CWP 63~178.</p>	<p>2</p> <p>PLUG FANS CWP 217~568.</p>	<p>3</p> <p>VARIABLE PITCH PULLEY CWP 890 & 1030.</p>	<p>4</p> <p>WIDE ESP Models with EC or Plug fans make airflow control simple.</p>
			
<p>5</p> <p>EXTERNAL CONTROL External controller can easily be connected through relay terminals.</p>	<p>6</p> <p>POWDER COATED CABINET Advanced powder coating ensures sheet metal life and provide a more aesthetically pleasing finish.</p>	<p>7</p> <p>TOP DISCHARGE SUPPLY AIR All models have a standard top supply air configuration however some larger models have an option for back supply air.</p>	<p>8</p> <p>COOLING WITH ELECTRIC HEATING CWP 60 ~ 178 models are available as cooling only with electric heaters. Heaters have double high temperature safeties.</p>
			
<p>9</p> <p>COOL ONLY CWP 890 & 1030 models are available made to order as cooling only.</p>	<p>10</p> <p>REVERSE CYCLE All CWP units are available as reverse cycle for projects that require heating from the water loop.</p>	<p>11</p> <p>KNOCK DOWN Units are available in knock down form for difficult to access plant rooms.</p>	<p>12</p> <p>SERVICE ACCESS Simple access to compressors and heat exchangers.</p>

How our water-cooled systems can change with the times

Rather than having to plan your entire air conditioning layout in advance, Temperzone's water-cooled modular technology offers you the unique ability to expand or adapt your system as a building's commercial demands evolve.

Multiple units can be used to cater for vastly different uses within the same building. For example, you can choose to cool or heat a large open-plan office area while also employing a range of separate water-cooled units to service 20 small meeting rooms.

And because each unit connects to an individual metre and power source, users are only billed for their own usage. It's just another way Temperzone's water-cooled range gives tenants complete control of their air conditioning needs.

CWP-K Series

The CWP-K Series of vertical discharge water cooled package units have been designed to provide year round comfort to the space they are serving.

The CWP-K units have been designed and developed to comply with AS / NZS 3823 specified conditions

The CWP-K units are available in four versions:

- RE - Reverse Cycle / Electric Heat
- R - Reverse Cycle
- CE - Cooling Only / Electric Heat
- C - Cooling Only

CWP 60 ~ 178 models are also available with either top condenser water connections, or front condenser water connections

Multiple CWP-K units are typically part of an overall hydronic system that incorporates some form of heat rejection equipment, usually a Cooling Tower or a Radiator cooler (Dry Cooler)

Refrigerant

Each unit is factory charged with refrigerant R410A, which is deemed to have an ODP (Ozone Depletion Potential) of Zero.

Evaporator Coil

Manufactured by temperzone, this is a die formed plate type, epoxy coated aluminium fins mechanically bonded to high efficiency rifle bored copper tube.

Condenser Coil

Manufactured by temperzone, this a copper / copper tube in tube type with refrigerant flow in the annular space and water counter flow in the inside tube. Tested to a maximum water pressure of 2760kPa (400psi)

Construction

Galvanised steel construction, the cabinet is finished in a baked powder coat finish, closed cell foam insulation is used, with a polyester galvanised sheet steel / baked polyester powder coat finish condensate drain tray, insulated to avoid sweating.

Compressor

A high efficiency scroll compressor or compressors are used within the units

Insulation

CWP units are well insulated to minimise condensation and attenuate noise.

Australian Made

CWP 63 ~ 1030 are manufactured in our Sydney Factory. The famous Australian Made logo is Australia's most trusted, recognised and widely used country of origin symbol, and is underpinned by a third-party accreditation system, which ensures products are certified as 'genuinely Australian'.



CWP Options & Features

The range of options available allow you to customise your desired unit, giving you ultimate control and flexibility.

Standard Range

Series	CWP	CWP	CWP	CWP
Model	63 ~ 178	217 ~ 568	890	1030
EC Fan Motor (Y) version	●	–	–	–
EC Plug Fan	–	●	□	□
AC Fan Motor version	–	–	●	●
Reverse Cycle	●	●	●	●
Cooling Only	□	□	□	□
Cooling / Electrical Heat	●	●	●	●
0-10VDC Fan Speed Control	●	●	□	□
1/2" panel filter	●	□	□	□
Number of circuits	1	2	2	4
Epoxy coated evaporator coil	●	●	●	●
Water hoses	□	–	–	–
TZ protection PCB	●	●	●	●

- Option
- Standard
- N/A

Flexible Handing Options

Flexible handing configurations available to suit the application.



Standard Handing

Std configuration	Water Connections
CWP 63 ~ 178	Top RH, or Front RH
CWP 217 ~ 374	Front RH
CWP 447 ~1030	Side RH



Opposite Handing

Std configuration	Water Connections
CWP 217 ~ 374	Front LH
CWP 447 ~1030	Side LH

Opposite handing units are not stocked. They are made to order for specific projects.

Additional Options & Accessories



Flexible Hoses

Hoses are an optional extra. There are difference hoses available depending on the model.

- CWP 63 (20mm x 600mm)
- CWP 83~109 (25mm x 800mm)
- CWP 132~178 (32mmx 1300mm)



Electronic Expansion Valve

EEV offers optimum control of superheat for outstanding comfort and humidity control Available as a custom option from the CWP 217 ~ 1030



Digital 1st Stage

Custom option available for improved capacity control. 0-100% continuous modulation enables wide capacity range and provides better humidity control at low capacity.

Available as a custom option from the CWP 217 ~ 1030

Water Sourced Integrated Systems

Temperzone's water sourced hydronic systems combine reverse cycle heat pumps, dry coolers and packaged water sourced units to offer a low GWP, high efficiency solution for commercial and residential tenanted buildings requiring independent metering and billing. Using a Temperzone dry cooler also reduces the high compliance costs associated with the use of cooling towers.

- Simultaneous heating and cooling system (heat recovery system)
- Connect any Temperzone water sourced packaged indoor units
- Advanced water sourced package unit controllers
- MAGNUS Heat Pump (MWR) - heating & cooling
- Temperzone modular air cooled condensers
- Thermostat controller / MODBUS

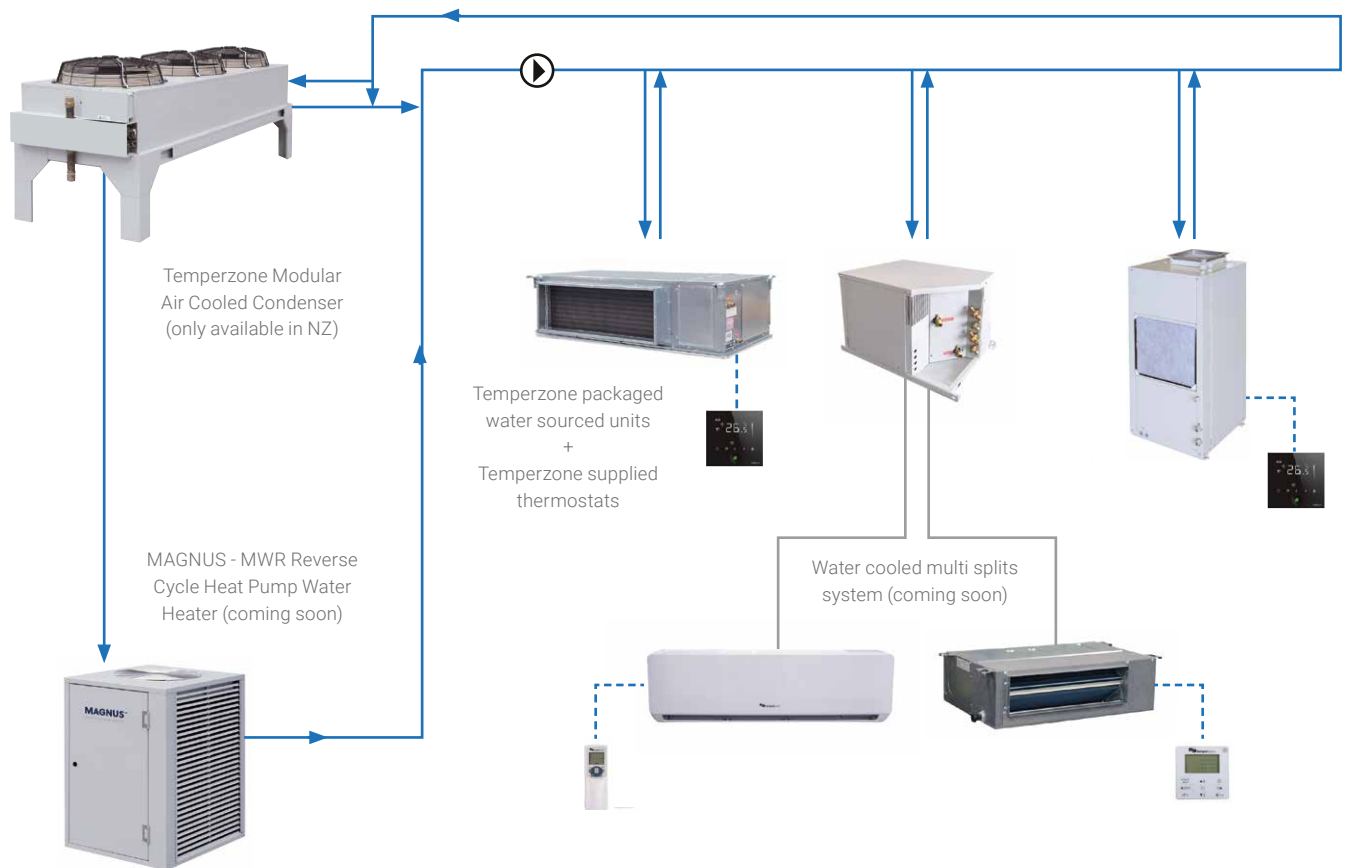

MAGNUS™
powerhouse water heaters

 **ThermoShell®**
technology

Eco Range HWP-Y Specifications Horizontal-Single Phase



Model	HWP 36Y	HWP 48Y	HWP 59Y	HWP 79Y	HWP 98Y
Capacity (Range) kW					
Nominal Cooling Capacity ² (kW)	3.5	4.4	5.9	8.1	9.9
Net Cooling Capacity (kW)	3.4	4.3	5.7	7.9	9.8
Efficiency Cooling (EER/AEER) ⁷	3.69 / 3.67	3.79 / 3.77	3.75 / 3.73	3.94 / 3.92	3.95 / 3.94
Heating Capacity ³ (kW)	3.7	4.6	5.4	8.9	11.3
Efficiency Heating (COP/ACOP)	4.08 / 4.04	4.17 / 4.14	3.87 / 3.85	4.36 / 4.35	4.35 / 4.34
Electric Heat Option (kW)	2	2	3	4	4
Nominal Supply Air Flow					
l/sec	190	230	320	500	560
Sound Pressure Level ⁴					
dB(a)	35	35	41	45	44
Power Supply ¹	Single Phase (230 - 240V 50Hz)				
Run Amps at Nominal Conditions ⁶	4.0	5.0	6.8	8.7	11.0
Heat Exchanger	ThermoShell®				
Water Flow					
l/sec	0.22	0.28	0.34	0.50	0.61
Water Pressure Drop					
kPa / psi	27.6 / 4	27.6 / 4	41 / 6	70 / 10	41 / 6
Water Connections					
ø mm / BSP	13 / ½"	13 / ½"	13 / ½"	19 / ¾"	19 / ¾"
Dimensions (mm)					
Width	928	928	1256	1213	1213
Height	355	355	355	415	415
Depth	788	788	788	781	781
Weight (kg)					
Weight (excluding water)	75	75	90	107	116

NOTES:

1 Voltage fluctuation limits: Single Phase models 200–252 V.a.c.

2 Nominal Cooling Capacity at AS/NZS 3823.1.3 conditions:

Entering Water Temperature 30°C;

Entering Air Temperature 27°C D.B., 19°C W.B.

3 Heating Capacity (HWP R version only) at AS/NZS 3823.1.3 conditions:

Entering Water Temperature 21°C;

Entering Air Temperature 21°C D.B.

4 SPL measured to JIS 8616 (1 m from source) at nominal supply air flow, with 1 m insulated duct.

5 Pressure Drops based on nominal water flow.

6 Reverse Cycle Series.

7 EER/AEER based on reverse cycle series

Materials and specifications subject to change without notice due to the manufacturer's ongoing research and development programme.

Eco Range HWP-Y Specifications Horizontal-Three Phase



Model	HWP 118Y	HWP 142Y	HWP 172Y	HWP 192Y	HWP 255Y	HWP 275Y
Capacity (Range) kW						
Nominal Cooling Capacity ² (kW)	12.2	14.7	18.5	21.2	25.5	27.5
Net Cooling Capacity (kW)	11.9	14.1	17.4	19.9	24.8	26.7
Efficiency Cooling (EER/AEER) ⁷	4.17 / 4.16	4.45 / 4.44	4.35 / 4.32	4.44 / 4.42	4.65 / 4.63	4.48 / 4.47
Heating Capacity ³ (kW)	11.6	14.5	16.7	18.6	23.0	24.6
Efficiency Heating (COP/ACOP)	3.92 / 3.91	4.36 / 4.35	4.28 / 4.25	4.32 / 4.30	4.59 / 4.58	4.37 / 4.36
Electric Heat Option (kW)	6	6	9	9	12	12
Nominal Supply Air Flow						
l/sec	620	775	1015	1160	1220	1400
Sound Pressure Level ⁴						
dB(a)	50	51	54	53	55	54
Power Supply ¹	3 Phase (400V 50Hz)					
Run Amps at Nominal Conditions ⁶	4.9 / 4.1 / 4.1	6.0 / 4.6 / 4.6	7.6 / 6.0 / 6.0	10.0 / 7.0 / 7.0	11.0 / 8.0 / 8.0	13.0 / 9.5 / 9.5
Heat Exchanger	ThermoShell®					
Water Flow						
l/sec	0.75	0.88	1.06	1.26	1.53	1.63
Water Pressure Drop						
kPa / psi	55 / 8	69 / 10	83 / 12	34 / 5	48 / 7	55 / 8
Water Connections						
ø mm / BSP	19 / ¾"	19 / ¾"	25 / 1"	25 / 1"	25 / 1"	25 / 1"
Dimensions (mm)						
Width	1283	1283	1513	1763	1998	2198
Height	425	507	507	507	507	507
Depth	781	831	831	831	831	831
Weight (kg)						
Weight (excluding water)	118	143	160	184	190	192

NOTES:

- 1 Voltage fluctuation limits: Single Phase models 200–252 V.a.c.
- 2 Nominal Cooling Capacity at AS/NZS 3823.1.3 conditions:
Entering Water Temperature 30°C;
Entering Air Temperature 27°C D.B., 19°C W.B.
- 3 Heating Capacity (HWP R version only) at AS/NZS 3823.1.3 conditions:
Entering Water Temperature 21°C;
Entering Air Temperature 21°C D.B.
- 4 SPL measured to JIS 8616 (1 m from source) at nominal supply air flow, with 1 m insulated duct.
- 5 Pressure Drops based on nominal water flow.
- 6 Reverse Cycle Series.
- 7 EER/AEER based on reverse cycle series

Materials and specifications subject to change without notice due to the manufacturer's ongoing research and development programme.

Standard Range HWP Specifications Horizontal-Single Phase



Model	HWP 36	HWP 48	HWP 59	HWP 79	HWP98
Capacity (Range) kW					
Nominal Cooling Capacity ² (kW)	3.5	4.4	5.9	8.1	9.9
Net Cooling Capacity (kW)	3.4	4.3	5.8	7.9	9.8
Efficiency Cooling (EER/AEER) ⁷	3.64 / 3.61	3.64 / 3.62	3.61 / 3.60	3.71 / 3.70	3.77 / 3.76
Heating Capacity ³ (kW)	3.7	4.6	5.4	8.9	11.1
Efficiency Heating (COP/ACOP)	3.82 / 3.79	3.66 / 3.64	3.62 / 3.61	4.18 / 4.16	4.22 / 4.21
Electric Heat Option (kW)	2	2	3	4	4
Nominal Supply Air Flow					
l/sec	190	230	320	500	560
Sound Pressure Level ⁴					
dB(a)	37	37	43	43	43
Power Supply ¹	Single Phase (230 - 240V 50Hz)				
Run Amps at Nominal Conditions ⁶	4.2	5.2	7.6	9.1	11.5
Heat Exchanger	ThermoShell®				
Water Flow					
l/sec	0.22	0.28	0.34	0.50	0.61
Water Pressure Drop					
kPa / psi	27.6 / 4	27.6 / 4	41 / 6	70 / 10	41 / 6
Water Connections					
ø mm / BSP	13 / ½"	13 / ½"	13 / ½"	19 / ¾"	19 / ¾"
Dimensions (mm)					
Width	928	928	1256	1213	1213
Height	355	355	355	415	415
Depth	788	788	788	721	721
Weight (kg)					
Weight (excluding water)	70	70	85	102	112

NOTES:

1 Voltage fluctuation limits: Single Phase models 200–252 V.a.c.

2 Nominal Cooling Capacity at AS/NZS 3823.1.3 conditions:

Entering Water Temperature 30°C;

Entering Air Temperature 27°C D.B., 19°C W.B.

3 Heating Capacity (HWP R version only) at AS/NZS 3823.1.3 conditions:

Entering Water Temperature 21°C;

Entering Air Temperature 21°C D.B.

4 SPL measured to JIS 8616 (1 m from source) at nominal supply air flow, with 1 m insulated duct.

5 Pressure Drops based on nominal water flow.

6 Reverse Cycle Series.

7 EER/AEER based on reverse cycle series

Materials and specifications subject to change without notice due to the manufacturer's ongoing research and development programme.

Standard Range HWP Specifications Horizontal-Three Phase



Model	HWP 118	HWP 142	HWP 172	HWP 192	HWP 255	HWP 275	HWP 370	HWP 445
Capacity (Range) kW								
Nominal Cooling Capacity ² (kW)	12.2	14.7	18.5	21.2	25.5	27.5	36.6	44.5
Net Cooling Capacity (kW)	11.9	14.1	17.4	19.9	24.7	26.9	34.65	42.2
Efficiency Cooling (EER/AEER) ⁷	3.84 / 3.83	3.80 / 3.79	4.24 / 4.22	4.11 / 4.09	4.29 / 4.28	4.23 / 4.22	3.71 / 3.70	3.41 / 3.41
Heating Capacity ³ (kW)	11.9	14.8	16.4	18.6	23.0	24.6	34.9	42.2
Efficiency Heating (COP/ACOP)	3.80 / 3.79	4.10 / 4.09	4.10 / 4.09	4.23 / 4.21	4.31 / 4.30	4.13 / 4.12	3.86 / 3.85	3.64 / 3.64
Electric Heat Option (kW)	6	6	9	9	12	12	18	24
Nominal Supply Air Flow								
l/sec	620	775	1015	1160	1220	1400	1900	2300
Sound Pressure Level ⁴								
dB(a)	48	48	48	45	47	55	63	64
Power Supply ¹	----- 3 Phase (400V 50Hz) -----							
Run Amps at Nominal Conditions ⁶	6.1 / 3.7 / 4.2	7.9 / 4.6 / 4.5	10.2 / 6.0 / 5.9	12.0 / 7.0 / 7.0	13.5 / 8.0 / 8.0	15.0 / 9.5 / 9.5	18.38 / 18.38 / 14.2	22.98 / 22.98 / 22.98
Heat Exchanger	----- ThermoShell® -----						----- Tube/Tube -----	
Water Flow								
l/sec	0.75	0.88	1.06	1.26	1.53	1.63	2.0	2.25
Water Pressure Drop								
kPa / psi	55 / 8	69 / 10	83 / 12	34 / 5	48 / 7	55 / 8	48.3 / 7	34.5 / 5
Water Connections								
ø mm / BSP	19 / ¾"	19 / ¾"	25 / 1"	25 / 1"	25 / 1"	25 / 1"	32 / 1¼"	32 / 1¼"
Dimensions (mm)								
Width	1283	1283	1513	1763	1998	2198	2050	2280
Height	425	507	507	507	507	507	655	673
Depth	721	771	771	771	771	771	875	875
Weight (kg)								
Weight (excluding water)	117	141	153	177	190	199	290	385

NOTES:

- 1 Voltage fluctuation limits: Single Phase models 200–252 V.a.c.
- 2 Nominal Cooling Capacity at AS/NZS 3823.1.3 conditions:
Entering Water Temperature 30°C;
Entering Air Temperature 27°C D.B., 19°C W.B.
- 3 Heating Capacity (HWP R version only) at AS/NZS 3823.1.3 conditions:
Entering Water Temperature 21°C;
Entering Air Temperature 21°C D.B.
- 4 SPL measured to JIS 8616 (1 m from source) at nominal supply air flow, with 1 m insulated duct.
- 5 Pressure Drops based on nominal water flow.
- 6 Reverse Cycle Series.
- 7 EER/AEER based on reverse cycle series

Materials and specifications subject to change without notice due to the manufacturer's ongoing research and development programme.

CWP Range Specifications Vertical-Single Phase



Model	CWP 63	CWP 83	CWP 96	CWP 109	CWP 132
Capacity (Range) kW					
Nominal Cooling Capacity ² (kW)	6.27	8.31	9.63	10.9	13.14
Net Cooling Capacity (kW)	6.14	8.09	9.37	10.58	12.77
Efficiency Cooling (EER/AEER) ⁷	3.53 / 3.51	3.64 / 3.58	3.56 / 3.55	3.53 / 3.51	3.52 / 3.51
Heating Capacity ³ (kW)	6.63	8.34	9.58	10.27	11.9
Efficiency Heating (COP/ACOP)	4.31 / 4.28	4.32 / 4.27	4.06 / 4.00	3.89 / 3.80	3.86 / 3.80
Electric Heat Option (kW)	2.5	3	4	4.5	5.5
Nominal Supply Air Flow					
l/sec	380	490	570	600	770
Sound Pressure Level ⁴					
dB(a)	55.1	60.4	63.4	63.4	58.6
Power Supply ¹	Single Phase (230 - 240V 50Hz)				
Run Amps at Nominal Conditions ⁶	7.5	9.7	11.4	15.3	16.0
Heat Exchanger	Tube/Tube				
Water Flow					
l/sec	0.42	0.5	0.58	0.67	0.8
Water Pressure Drop					
kPa / psi	20.7 / 3	27.6 / 4	34.5 / 5	27.6 / 4	41.4 / 6
Water Connections					
ø mm / BSP	19 / ¾"	25 / 1"	25 / 1"	25 / 1"	32 / 1¼"
Dimensions (mm)					
Width	740	740	740	740	855
Height	1430	1465	1465	1465	1400
Depth	650	650	650	650	780
Weight (kg)					
Weight (excluding water)	150	170	170	176	216

NOTES:

- Voltage fluctuation limits: Single Phase models 200–252 V.a.c.
- Nominal Cooling Capacity at AS/NZS 3823.1.3 conditions:
Entering Water Temperature 30°C;
Entering Air Temperature 27°C D.B., 19°C W.B.
- Heating Capacity (HWP R version only) at AS/NZS 3823.1.3 conditions:
Entering Water Temperature 21°C;
Entering Air Temperature 21°C D.B.
- SPL measured to JIS 8616 (1 m from source) at nominal supply air flow, with 1 m insulated duct.
- Pressure Drops based on nominal water flow.
- Reverse Cycle Series.
- EER/AEER based on reverse cycle series

Materials and specifications subject to change without notice due to the manufacturer's ongoing research and development programme.

CWP Range Specifications Vertical-Three Phase



Model	CWP 109	CWP 132	CWP 178	CWP 217	CWP 266
Capacity (Range) kW					
Nominal Cooling Capacity ² (kW)	10.87	13.14	17.8	21.74	26.28
Net Cooling Capacity (kW)	10.58	12.77	17.25	21.16	25.54
Efficiency Cooling (EER/AEER) ⁷	3.53 / 3.51	3.52 / 3.51	3.58 / 3.52	3.51 / 3.50	3.7 / 3.6
Heating Capacity ³ (kW)	10.27	11.9	16.41	20.54	23.8
Efficiency Heating (COP/ACOP)	3.89 / 3.80	3.86 / 3.80	3.98 / 3.97	4.10 / 4.00	3.84 / 3.78
Electric Heat Option (kW)	4.5	5.5	6.5	8	10
Nominal Supply Air Flow					
l/sec	600	770	920	1210	1535
Sound Pressure Level ⁴					
dB(a)	63.4	58.6	62.9	69.3	66.3
Power Supply ¹	Three Phase (400V 50Hz)				
Run Amps at Nominal Conditions ⁶	5.8 / 4.5 / 4.4	6.0 / 5.7 / 5.7	8.2 / 8.0 / 8.0	10.2 / 10.2 / 10	12.0 / 11.4 / 11.4
Heat Exchanger	Tube/Tube				
Water Flow					
l/sec	0.67	0.8	1.08	1.34	1.60
Water Pressure Drop					
kPa / psi	27.6 / 4	41.4 / 6	34.5 / 5	27.6 / 4	27.6 / 4
Water Connections					
ø mm / BSP	25 / 1"	32 / 1¼"	32 / 1¼"	38 / 1½"	38 / 1½"
Dimensions (mm)					
Width	740	855	855	1320	1520
Height	1465	1400	1400	1490	1490
Depth	650	780	780	1035	1035
Weight (kg)					
Weight (excluding water)	176	216	226	330	460

NOTES:

- Voltage fluctuation limits: Single Phase models 200–252 V.a.c.
- Nominal Cooling Capacity at AS/NZS 3823.1.3 conditions:
Entering Water Temperature 30°C;
Entering Air Temperature 27°C D.B., 19°C W.B.
- Heating Capacity (HWP R version only) at AS/NZS 3823.1.3 conditions:
Entering Water Temperature 21°C;
Entering Air Temperature 21°C D.B.
- SPL measured to JIS 8616 (1 m from source) at nominal supply air flow, with 1 m insulated duct.
- Pressure Drops based on nominal water flow.
- Reverse Cycle Series.
- EER/AEER based on reverse cycle series

Materials and specifications subject to change without notice due to the manufacturer's ongoing research and development programme.

CWP Range Specifications Vertical-Three Phase



Model	CWP 374	CWP 447	CWP 568	CWP 890	CWP 1030
Capacity (Range) kW					
Nominal Cooling Capacity ² (kW)	37.44	44.7	57.5	89.0	101.6
Net Cooling Capacity (kW)	36.13	42.9	55.7	86.9	94.5
Efficiency Cooling (EER/AEER) ⁷	3.65 / 3.64	3.37 / 3.36	3.72 / 3.65	3.45 / 3.22	2.94 / 2.92
Heating Capacity ³ (kW)	35.5	46.6	54.9	84.4	98.6
Efficiency Heating (COP/ACOP)	4.06 / 4.05	3.99 / 3.98	4.0 / 3.90	3.59 / 3.58	3.31 / 3.30
Electric Heat Option (kW)	15	21	22.5	34.5	39
Nominal Supply Air Flow					
l/sec	1940	2315	2935	4600	4960
Sound Pressure Level ⁴					
dB(a)	72.3	69.3	69.3	82	81
Power Supply ¹	----- Three Phase (400V 50Hz) -----				
Run Amps at Nominal Conditions ⁶	16.7 / 16.3 / 16.3	22.3 / 21.9 / 22.1	31.8 / 36.4 / 30.8	45.1 / 46.0 / 45.7	60.3 / 60.3 / 57.1
Heat Exchanger	----- Tube/Tube -----				
Water Flow					
l/sec	2.27	2.6	3.4	4.9	5.7
Water Pressure Drop					
kPa / psi	27.6 / 4	27.6 / 4	27.6 / 4	34.5 / 5	31.05 / 4.5
Water Connections					
ø mm / BSP	51 / 2"	51 / 2"	51 / 2"	64 / 2½"	76 / 3"
Dimensions (mm)					
Width	1520	2070	2070	1990	2360
Height	1745	1845	2100	1905	2225
Depth	1035	1090	1090	1160	1365
Weight (kg)					
Weight (excluding water)	530	655	770	795	1140

NOTES:

- Voltage fluctuation limits: Single Phase models 200–252 V.a.c.
- Nominal Cooling Capacity at AS/NZS 3823.1.3 conditions:
Entering Water Temperature 30°C;
Entering Air Temperature 27°C D.B., 19°C W.B.
- Heating Capacity (HWP R version only) at AS/NZS 3823.1.3 conditions:
Entering Water Temperature 21°C;
Entering Air Temperature 21°C D.B.
- SPL measured to JIS 8616 (1 m from source) at nominal supply air flow, with 1 m insulated duct.
- Pressure Drops based on nominal water flow.
- Reverse Cycle Series.
- EER/AEER based on reverse cycle series

Materials and specifications subject to change without notice due to the manufacturer's ongoing research and development programme.



Temperzone Customer Care

Temperzone Customer Care is designed to deliver the highest level of support and accessibility to all our customers. This program provides factory trained technicians with the ability to resolve issues on-site, significantly reducing guesswork from commissioning.

With Temperzone products continually evolving to provide higher levels of efficiency, control and protection we want our customers to have the comfort of knowledge that Temperzone will be there right along-side them for the entire product life cycle.

Temperzone offers a wide range of training courses in application, service and commissioning.



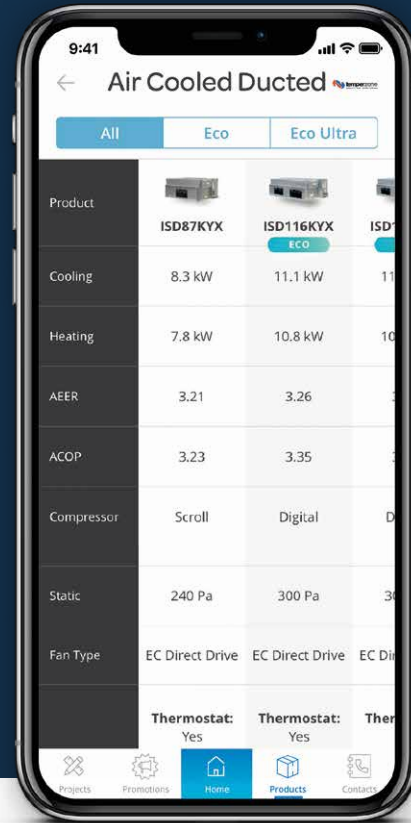

WiFi Service Utility Tool

WiFi Service Utility (WSU) is a portable control interface that plugs directly into the UC6, UC7 & UC8 board on a Temperzone Air Conditioning Unit. It allows you to monitor a wide range of operational parameters, view fault logs and even take control of the unit. It has its own WiFi network built in and the control and diagnostics are done wirelessly from a smartphone, tablet or notebook PC.



Temperzone Access App

Designed with simple access to information in mind, our app allows you to browse temperzone product ranges and view product specs - giving you access to detailed information, wherever you are. Create personalised projects and add product information for efficient & effective project management. Search temperzone Access via the App store or Google Play to download today.



www.temperzoneaccess.com

Temperzone Australia Pty Ltd

ENQUIRIES

Australia: sales@temperzone.com.au
New Zealand: nzsales@temperzone.com
Singapore: sales@temperzone.com.sg

AUSTRALIA

Sydney: (02) 8822 5700
Adelaide: (08) 8115 2111
Brisbane: (07) 3308 8333
Melbourne: (03) 8769 7600

DISTRIBUTORS

Newcastle: (02) 4962 1155
Perth: (08) 6399 5900
Launceston: (03) 6331 4209

NEW ZEALAND

Auckland: (09) 279 5250
Wellington: (04) 569 3262
Christchurch: (03) 379 3216

ASIA

Singapore: (65) 6733 4292
Shanghai: (21) 5648 2078

temperzone.com
temperzone.biz

